

KneeGuard Kids 3



Assembly- and
instruction manual



INSTRUCTION
VIDEO

Warning

- This product is not designed to protect against shock caused by a car crash.
- This product is designed to be a footrest and should be used as such.
- Do not stand on the footrest or use as a step to get into the car seat.

Caution

- Cannot be used for car seats with a Load Leg.
- Can be used when detaching a Load (support) Leg.

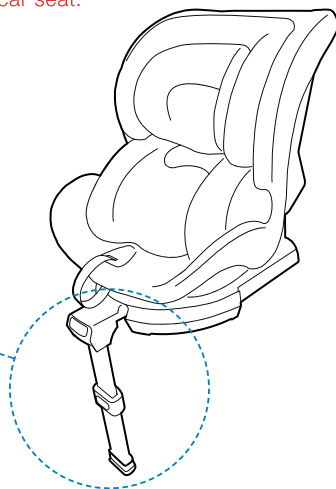

Box Contents

➤ Please ensure below contents before using.

➤ Assembled the Height Control Bar and the Load Leg is included.

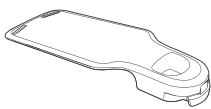

1 Installing Plate

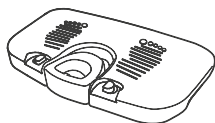

1 Foot Plate

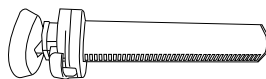

1 Load Leg

+

1 Height Control Bar

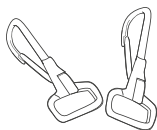

2 ISOFIX Hooks

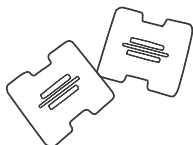

2 Installing Clips

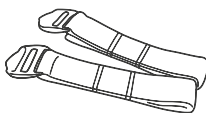

2 Belts



1 Instruction Manual

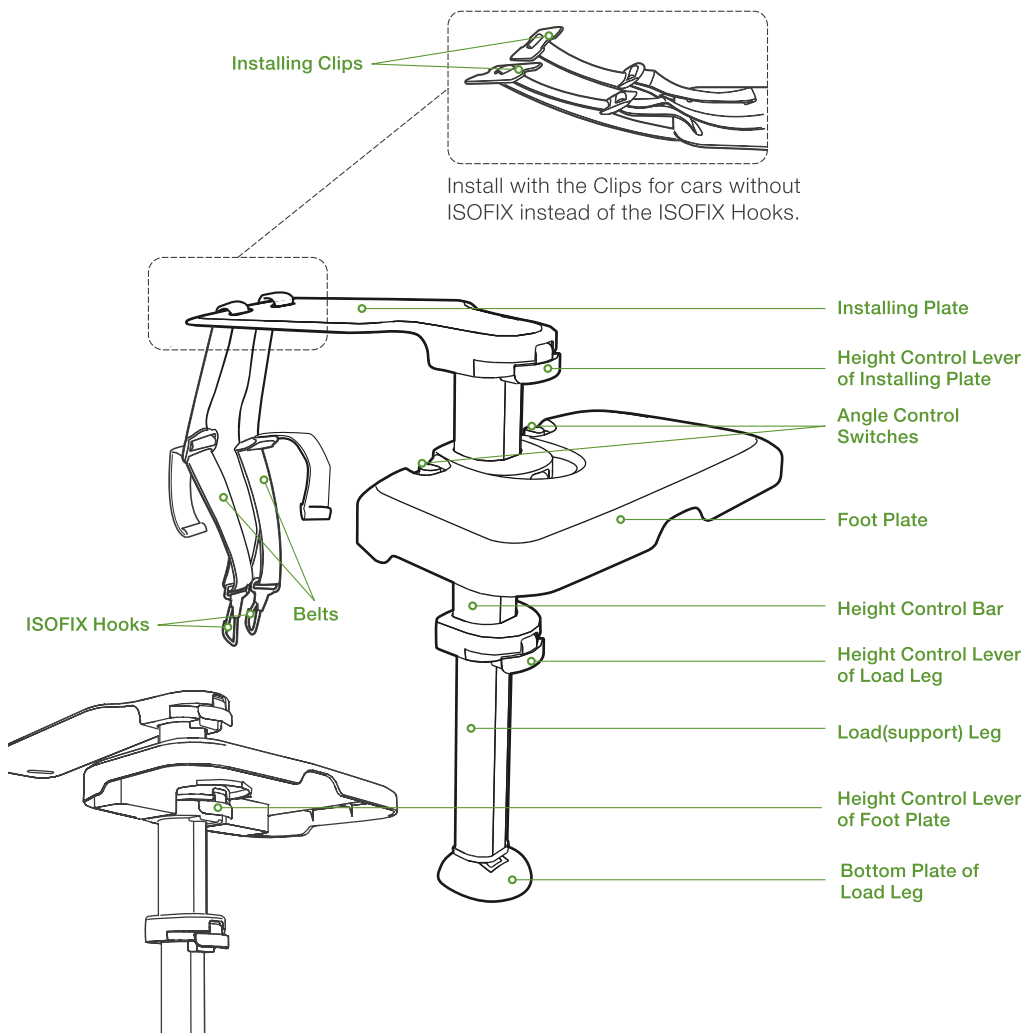

Foot Plate dimensions (L x W): 36,7 x 21,5 cm
 To use KneeGuardKids 3, you need to have the space at least 22 cm.

Assembling Method

For infant & convertible car seat (Ages 3 and under)

Assemble the Installing Plate first and then the Foot Plate.

STEP 1: Assemble the Installing Plate

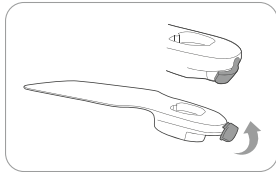

Lift the lever of Installing Plate.

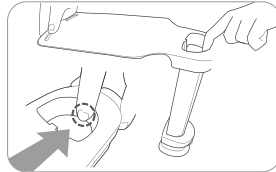

Pushing the button (protrusion) of the Installing Plate hole inside, join the Installing Plate and the Height Control Bar.

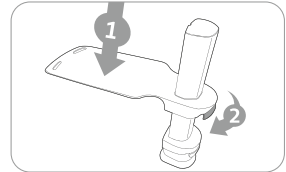

Place the Installing Plate in the middle of the Height Control Bar and then pull down the lever.

➤ You can pull down the Height Control Lever by using slight up and down movements to match the groove and uneven surface.

STEP 2: Assemble the Foot Plate

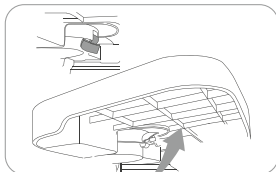

Lift the lever of Foot Plate.

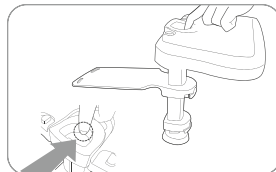

Pushing the button (protrusion) of the Foot Plate hole inside, join the Foot Plate and the Height Control Bar.

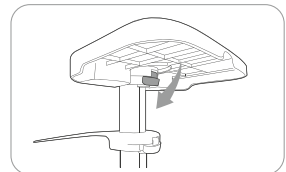

Place the Foot Plate on top of the Height Control Bar and then pull down the lever.

➤ You can pull down the Height Control Lever by using slight up and down movements to match the groove and uneven surface.

Attaching the Belts with ISOFIX Hooks (cars with ISOFIX)

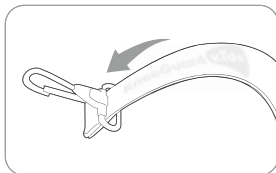

Holding the Belt with engraved logo side, insert the Belt to the ISOFIX Hook from top to bottom.

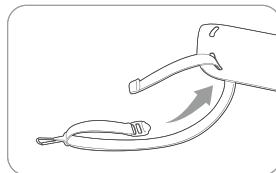

Insert the Belt to hole in the back of the Installing Plate from bottom to top.

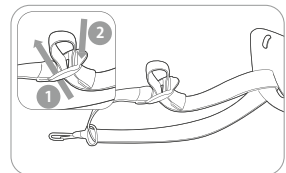

Insert the Belt into the length adjustable buckle.

(➤ Please follow the steps as described in the above picture.)

➤ Install with the Clips for cars without ISOFIX instead of the ISOFIX Hooks.
Please refer on page 13 for a detailed attaching method of the Clips.

For booster & junior car seat (ages 4 and over)

Assemble the Foot Plate first and then Installing Plate after.

STEP 1: Assemble the Foot Plate

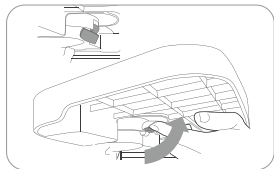

Lift the lever of Foot Plate.

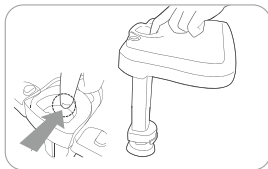

Pushing the button (protrusion) of the Foot Plate hole inside, join the Foot Plate and the Height Control Bar.

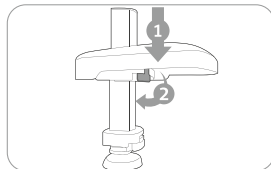

Place the Foot Plate in the middle of the Height Control Bar and then pull down the lever.

➤ You can pull down the Height Control Lever by using slight up and down movements to match the groove and uneven surface.

STEP 2: Assemble the Installing Plate

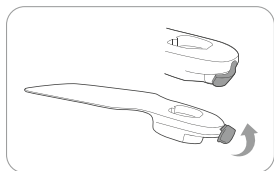

Lift the lever of Installing Plate.

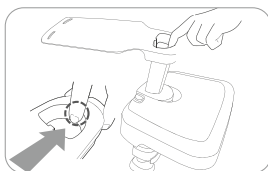

Pushing the button (protrusion) of the Installing Plate hole inside, join the Installing Plate and the Height Control Bar.



Place the Installing Plate on top of the Height Control Bar and then pull down the lever.

➤ You can pull down the Height Control Lever by using slight up and down movements to match the groove and uneven surface.

Attaching the Belts with Installing Clips (cars without ISOFIX)

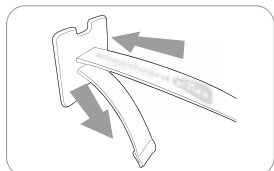

Holding the Belt with engraved logo side, insert it into the top hole of the Installing Clip, and then pull it out again through the bottom hole.

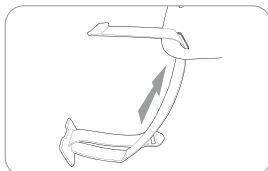

Insert the Belt to hole in the back of the Installing Plate from bottom to top.

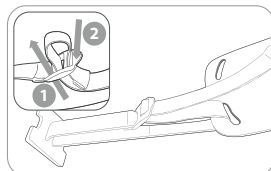

Insert the Belt into the length adjustable buckle.

(➤ Please follow the steps as described in the above picture.)

➤ Install with the Hooks for cars with ISOFIX instead of the Clips.
Please refer on page 12 for a detailed attaching method of the Hooks.

Installing method

Cars with ISOFIX (install with ISOFIX Hooks)

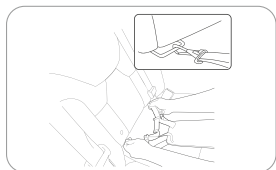

Hang the ISOFIX Hooks from top to bottom on the ISOFIX LATCH.

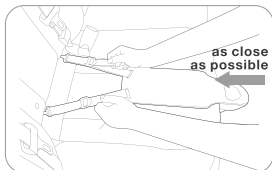

Place the Height Control Bar close to the vehicle seat and then fasten the Belts.

(> If the Height Control Bar is not firmly contacted to the vehicle seat, the Foot Plate may shake.)

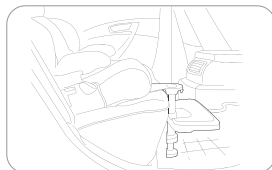

After install the car seat on the Installing Plate, adjust height of the Foot Plate and the Load Leg for the comfort level of your kid.

(> Please refer to page 15 for a detailed height adjustment method)

Cars without ISOFIX (install with Clips)

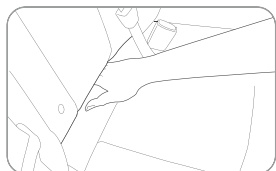

Insert your hand in the gap (seat bight) between the cushion and the back of the vehicle seat to check if there is enough room for the Installing Clips.

(> Safety first, make sure your hand is safe.)

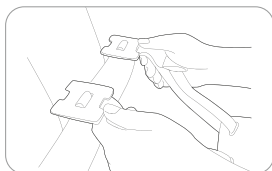

Hold the Installing Clips horizontally facing upside.

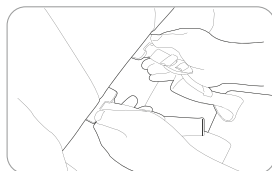

Insert the Installing Clips into the gap as shown while keeping its face downward.

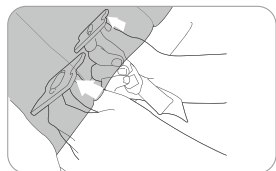

Push the Installing Clips horizontally all the way and then push and stand the Clips vertically.

(> If you cannot stand the Clips vertically, push the Installing Clips further downward.)



Place the Height Control Bar close to the vehicle seat and then fasten the Belts.

(> If the Height Control Bar is not firmly contacted to the vehicle seat, the Foot Plate may shake.)

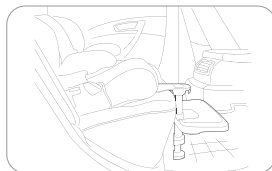

After install the car seat on the Installing Plate, adjust height of the Foot Plate and the Load Leg for the comfort level of your kid.

(> Please refer to page 15 for a detailed height adjustment method.)

Height Adjustment method

For infant & convertible car seat (ages 3 and under)

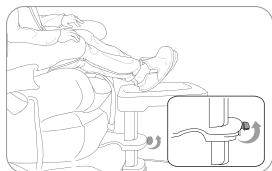

Place the kid on the car seat and lift the lever of Installing Plate.

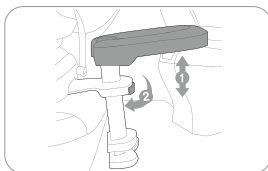

Adjust height of the Foot Plate to match the feet of the kid and then pull down the lever.

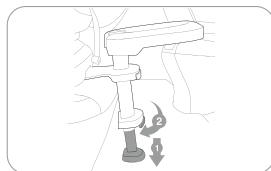

Lift the lever of Load Leg. Adjust the height of Load Leg to reach the floor of the vehicle and then pull down the lever.

For booster & junior car seat (ages 4 and over)

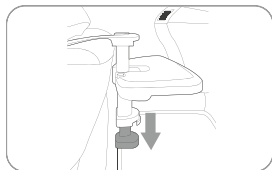

Lift the lever of Load Leg. Adjust the height of Load Leg to reach the floor of the vehicle and then pull down the lever.

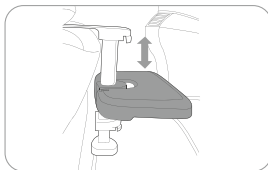

Place the kid on the car seat and lift the lever of Foot Plate. Adjust height of the Foot Plate to match the feet of the kid and then pull down the lever.

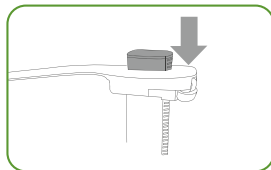

► Caution

If your vehicle's seat is lower than others, assemble the Installing Plate to low position of the Height Control Bar.

Angle Adjustment method

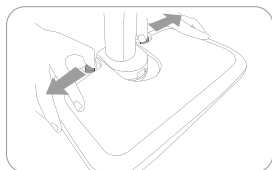

Push both of the Angle Control Switches outward.

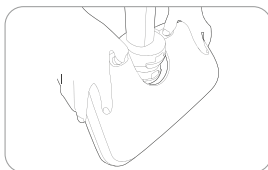

After release the switches at desired angle, gently shake the Foot Plate up and down so that the switches return to its original position.

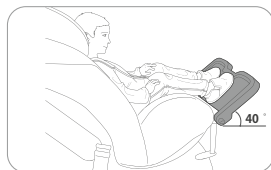

The sole is inclined by about 40 degrees, so it is more comfortable for infants to adjust angle of the Foot Plate to 40 degrees.

About the product

- Product: Car seat Footrest
- Model: KneeGuardKids 3 INNO SENSE
- Recommended Age: 9 years and under (less than 30 kg)
- Dimensions (L x W x H):
Installing Plate: 36 × 13,3 × 3,5 cm / Foot Plate: 36,7 × 21,5 × 4 cm /
Height Control Bar: 7,4 × 7,4 × 28,3 cm / Load Leg: 7,4 × 8 × 28,7 cm
- Weight: 1,2 kg
- Materials: ABS, PP, PC
- Manufacture: inGarden Corporation
- Country of Origin: South Korea

Cautions

- Mount firmly and securely using the ISOFIX Hooks or Installing Clips.
- Board the vehicle after fully folding the Foot Plate and use it after unfolding them.
- Do not stand on the footrest or use as a step to get into the car seat.
- Height and angle adjustment should be made by an adult when the vehicle is not in motion.
- Remove them when not in use for a long time and keep them separately.
- When it is dirty, please clean it with a gentle detergent.
- **CE** - certified

Warranty

- This product was manufactured under strict quality control process.
- The 6 month warranty for KneeGuardKids 3 begins on the date of purchase.
- During the warranty period, defective products will be A/S or replaced free of charge.
- Damage caused by the customer, normal loss of parts will not be A/S or replaced free of charge even during the warranty period.

Distributed by:  **BABYPLUS**
THE FUN COMPANY

BABY-PLUS eG • Tiefe Gasse 11-13 • D-97084 Würzburg
Telefon: +49 (0) 931/2 99 25-0 • www.baby-plus.de